

SOFT31 (DN 15-25)



Trusted Partners.
Innovative Solutions.

Single Orifice Float Trap with SLR and/or TV

Description

The Forbes Marshall Single Orifice Float Trap, SOFT31, is a cast iron single orifice float trap available with an integral automatic air venting facility. It is available with horizontal or vertical connections with flow downwards. As an alternative a manual needle valve can be added and used as a steam lock release.

Sizes and Pipe Connection

DN 15, 20 and 25 Screwed BSPT/NPT

Note: Available with IBR certificate on request

Available Types

SOFT31-T TV with Thermostatic air Vent (TV)

SOFT31-S with Steam Lock Release (SLR)

SOFT31-ST combined TV and SLR

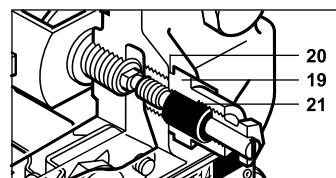
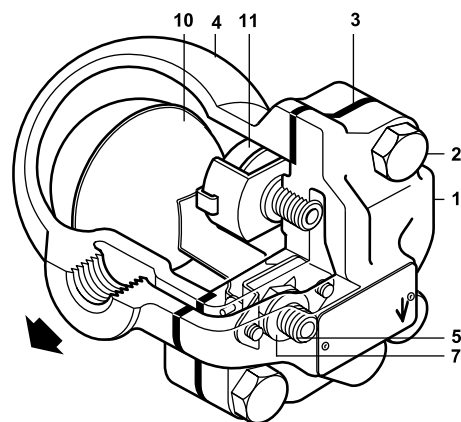

Limiting Conditions

PMA Maximum allowable pressure	13 bar g at 220 °C
TMA Maximum allowable temperature	220 °C at 13 bar g
PMO Maximum operating pressure	13 bar g
TMO Maximum operating temperature	220 °C at 13 bar g
Minimum operating temperature	0 °C
ΔPMX Maximum differential pressure	
SOFT31-4.5	4.5 bar g
SOFT31-10	10 bar g
SOFT31-13	13 bar g
Cold hydraulic test pressure	26 bar g

Material

Sr.No	Part	Material	Standard
1.	Cover	Cast Iron	IS 210 FG 260
2.	Cover bolts	Carbon Steel	H.T.IS1367, Gr8
3.	Cover gasket	Asbestos free synthetic fibre	
4.	Base	Cast Iron	IS 210 FG 260
5.	Main valve seat	Stainless Steel Type 304	ASTM A743 Gr. CA40
6.	Main valve seat gasket		
7.	Main valve assembly screws	Stainless Steel Type 304	IS-1364
8.	Ball float & lever	Stainless Steel Type 304	ASTM A240
9.	Air vent element	Stainless Steel Type 316	ASTM A240
10.	SLR unit	Stainless Steel Type 410	ASTM A276
11.	SLR unit gasket	Stainless Steel Type 304	ASTM A240
12.	Pivot frame type 304	Stainless Steel	ASTM A240
13.	SLR Seal	Graphite	

Operating range

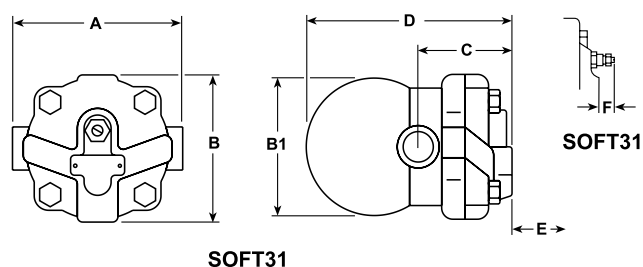
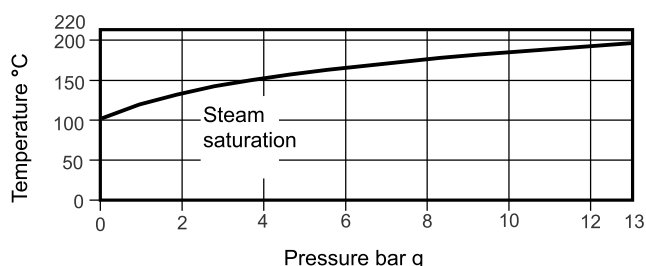

Dimensions (approx.) in mm:

Size (DN)	A	B	C	D	E	F	Wt.(kg)
15/20 (NIBR)	121	107	67	147	105	30	2.5
15/20 (IBR)	130	109	72	152	120	20	2.9
25 (IBR/NIBR)	141	109	72	160	135	20	4.0

General Tol : ±3

Capacity Chart

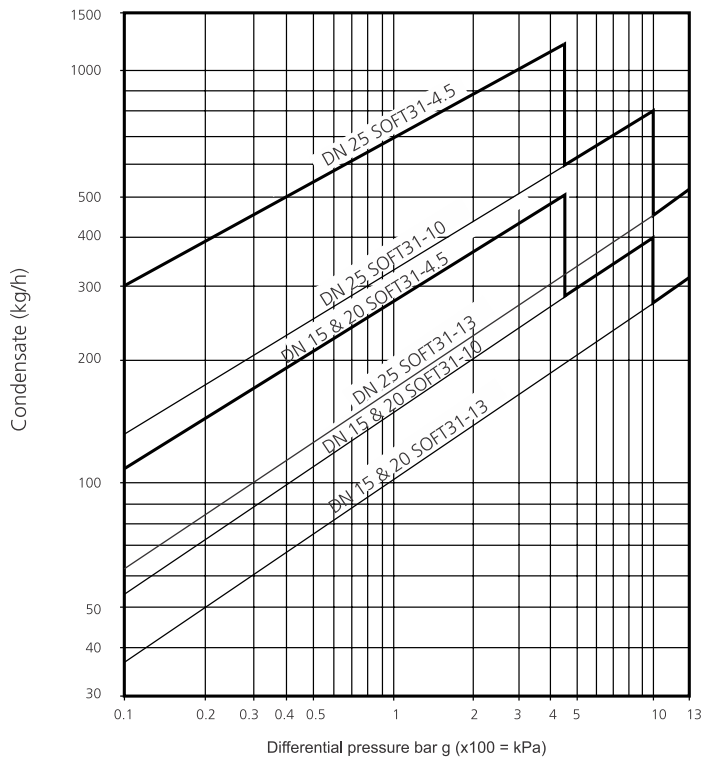

How to Order

DN 15 Single Orifice Float Trap, SOFT31-T-4.5 bar g, TV, screwed BSPT

Available Spares

The parts available as spares are shown in heavy outline. Parts drawn in dotted line are not available as spares.

Main valve assembly with Float	A, B, C, D, (2 OFF) E, F
Air Vent Assembly	H, J, L, M, N
Steam Lock Release Unit	OP
Cover Gasket (packet of 5)	T
Float	C
Screen (Packet of 5)	—

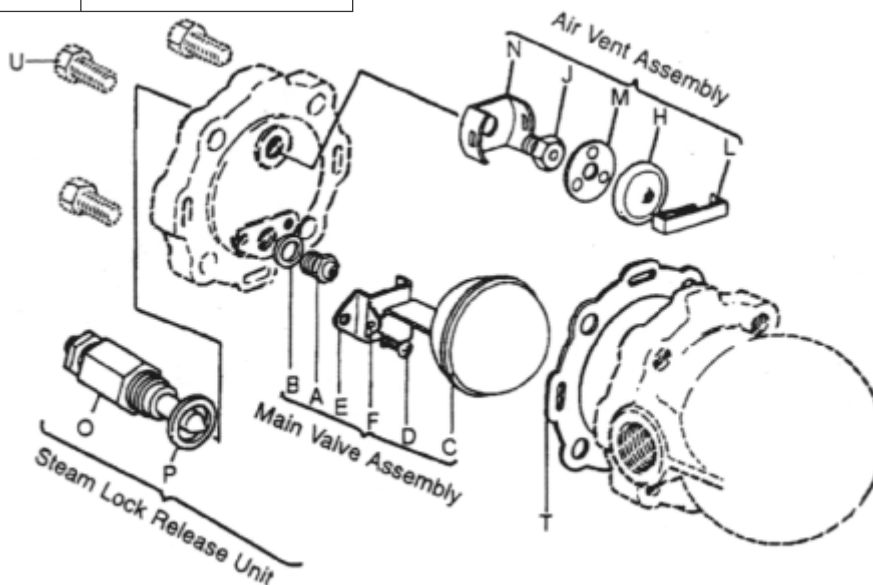

How to Fit - General

With suitable isolation, repairs can be carried out with the trap on line. When reassembling it is advisable to make sure that all joint faces are clean.

How to Fit Main Valve Assembly

- Remove cover bolts U and lift off cover
- Remove complete float assembly by undoing the two screws D.
- Remove main valve seat A and replace with a new one supplied with a new gasket B.
- Fit complete new float assembly by tightening the assembly set screws D.
- Refit the cover using new gasket T.

How to Fit Air Vent Assembly

- Remove spring clip L, element H and spacer plate M.
- Unscrew seat, frame N assemble spacer plate, fit element and dip.
- Align complete air vent horizontally so that the frame clears the cover.

Recommended Tightening Torques

Part		Torque (Nm)
Main Valve Seat (A)	18 mm A/F	50/55
Main Valve Assembly Screws (D)		2.5/3
Air Vent Seat (J)	17 mm A/F	50/55
Steam Lock Release Seat (S)	17mm A/F	50/55
Cover Bolts	17 mm A/F	40/55

How to Order Spares

Always order spares by using the description given in the column above and stating the size of the trap.

Example : Main valve assembly for DN 15 Single Orifice Float Trap SOFT31-T-4.5